

TYPE 2 - 350 SERIES (3-1/2" THROAT) W/ 1-1/4" REVEAL TRIM
WALL END CAP

K

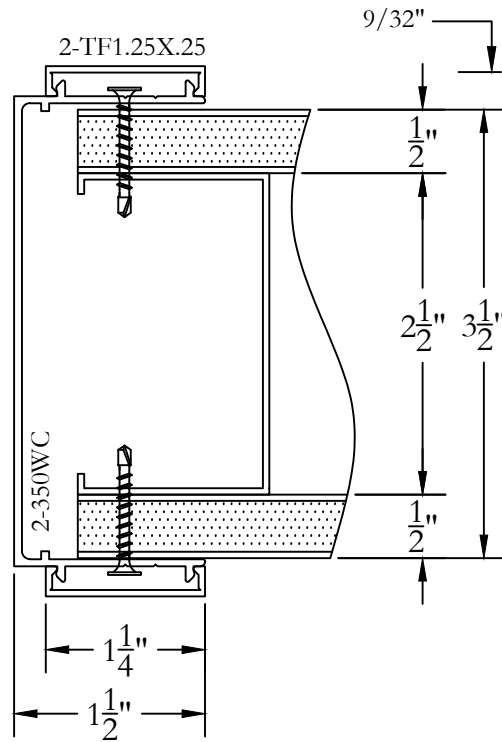

Frameworks Manufacturing Phone: 713-692-5222
1910 Cypress Station Dr www.frameworks.com
Suite #100 email: orders@frameworks.com
Houston, Texas 77090