

TYPE 1 - 375 SERIES (3-3/4" THROAT)
GLASS BASE (FLOOR)

F1

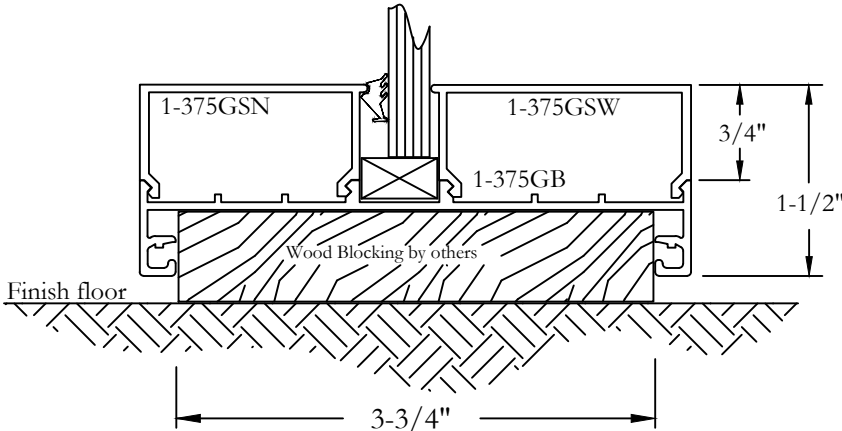

Frameworks Manufacturing Phone: 713-692-5222
1910 Cypress Station Dr www.frameworks.com
Suite #100 email: orders@frameworks.com
Houston, Texas 77090