

TYPE 2 - 375 SERIES (3-3/4" THROAT) W/ 1-1/2" FLUSH TRIM
4" GLASS BASE

F2

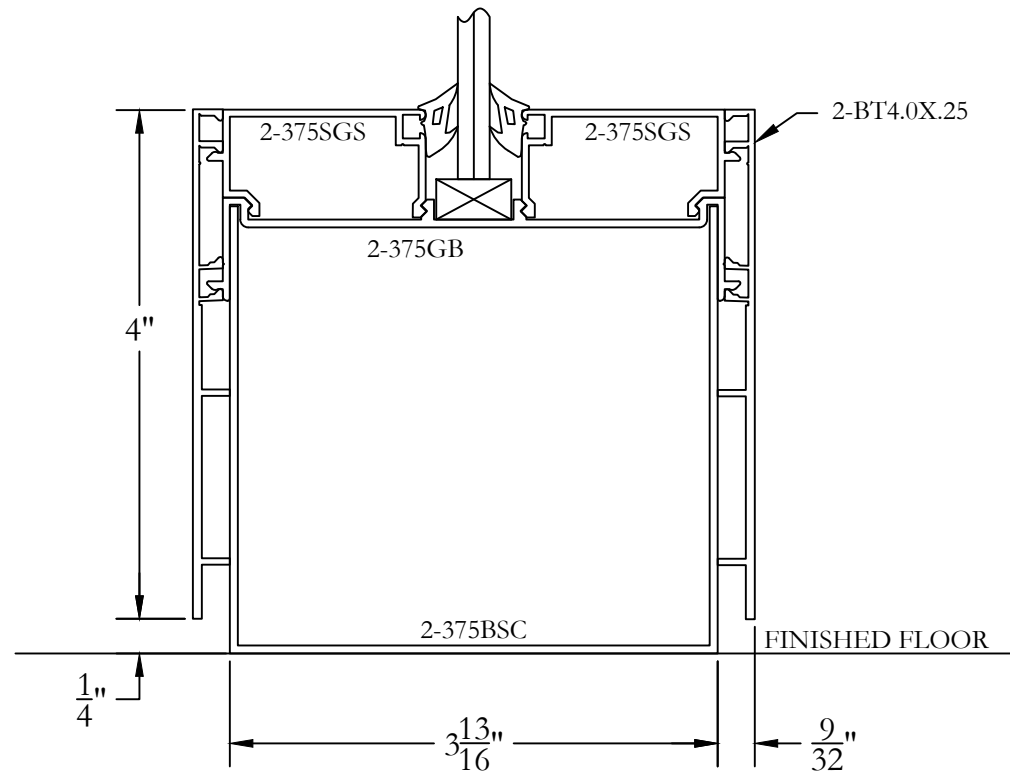

Bringing new light to interior architecture



Frameworks Manufacturing
1910 Cypress Station Dr
Suite #100
Houston, Texas 77090

Phone: 713-692-5222
www.frameworks.com
email: orders@frameworks.com